

SPECIFICATION FOR APPROVAL

MODEL NAME : INC-2363FHAZIG

Customer:



Revision	Date	History
V0.1	2022.07.13	Initial Release

Draft _____

Date : _____

Checked: _____

Date : _____

Approved : _____

Date : _____

Contents

1. GENERAL DESCRIPTION

- 1.1 Overview
- 1.2 General Specifications
- 1.3 Environmental and Reliability Specification
- 1.4 Power Supply Rating

2. USER CONTROL & OSD

- 2.1 Key Control board
- 2.2 OSD Control function
- 2.3 OSD GUI Control table

3. CONNECTOR DESCRIPTION

- 3.1 Summary
- 3.2 J7: DP Input Connector
- 3.3 J1: VGA Input Connector
- 3.4 J2: 12VDC Power Input Jack
- 3.5 J6: 24VDC Power Input Jack
- 3.6 J4: 12VDC/5VDC External Output Connector
- 3.7 J5 / J8: LCD Backlight Inverter Connector
- 3.8 J9: 12VDC / 24VDC SMPS Power Input Connector
- 3.9 J10: Auto Dimming/RS-232C Connector
- 3.10 J14 / J16: LCD Interface Connector
- 3.11 J15: OSD Board Connector
- 3.12 J26: Speaker Output Connector
- 3.13 J901: DVI Input Connector
- 3.14 J904: VGA/DVI Audio Input Connector

4. STANDARD DISPLAY MODE

5. LED Backlight Driver Board Specification

6. Board Dimensions

7. LED Lighting Control Specification

8. Packing Information

9. Mechanical Structure

1. General Description

1.1 Overview

Impact Display Components open frame LCD Monitor INC-2363FHAZIG is a high performance TFT LCD monitor providing high quality image from the analog RGB, DVI-D and DP input.

This monitor supports wide range signal input from VGA to Full HD resolution at vertical refresh rate of 60Hz.

It is designed for industrial use with Auto power on, up scaling performance adequate for low-resolution application and enhanced design margin for reliability.

It also gives versatile optional features like Touch Screen custom designed frame

1.2 Reference table of characteristics

LCD Panel	Size	23.6" Round
	Active Display Area	600.384(H) x 600.384(V)mm
	Type No.	AUO P236RVN01.0 (23.6" Round Type)
	Number of Pixels	848(H) x 848(V) / T-CON Board 1920 (H) x 1080 (V)
	Pixel Arrangement	RGB Vertical Stripe
	Pixel Pitch	0.708mm x 0.708mm
	Color Depth	16.7M True Colors
	Surface Treatments	Anti Glare Haze 28% / 3H
	Viewing Angle (CR>10)	R/L: 178 degree (89/89) U/D: 178 degree (89/89)
	Contrast Ratio	4000 : 1
	Response Time(Typ.)	8ms
	Average Brightness	Typ. 700 cd/ m ²
	Frame Rate	Typ. 60Hz
	Backlight Unit	LED
Outline Dimension	663.781(H) x 663.781 (V) x 27.4(D)	
Resolution	Prime	1920 x 1080 @ 60 Hz
	Standard	640x480 @60/72/75Hz 800x600 @60/72/75Hz, 1024x768 @60/70/75Hz, 1280x1024 @60/75Hz, 1280x720@60Hz 1366x768@60Hz,1600x900@60Hz, 1680x1050@60Hz,1920x1080@60Hz

Input Signal Interface	VGA	15pin D-Sub x 1Port
	DVI-D	24pin DVI-D x 1 Port
	DP(Display Port)	20pin DP Jack x 1 Port
	Audio Input	3.5Pai Stereo Jack x 1 Port
	Power Jack	Power Mini-Din 4P x 1 Port
Scanning Frequency	Horizontal	31 ~ 80Khz
	Vertical	55 ~75Hz
OSD Control		Menu, Select, Up, Down, Power
Plug & Play		VESA DDC 2B Ver1.3
Safety Glass		720.0mm(H) x 720.0mm(V) x 3.0T
LED Frame Illumination (Without Controller)		Edge / Front Type, 4 sided
		LED Type : Dual Line w/IC type (BT5050B)
		Supports External 5V Addressable, w/IC type LED Lighting Controller
		Interface Port : Molex 43020-0600
RoHS		RoHS Compliance



Application Caution

1.Precautions for strong light exposure

Strong light exposure causes degradation of polarizer and color filter.

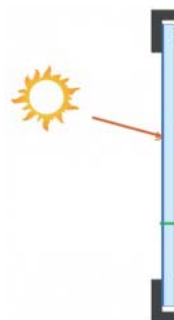

2. Using Conditions

- Temperature inside the cabinet should be controlled 'at room temp' (0 ~ 40°C) by cooler and fan.

1.3 Environmental and Reliability Specification

- This specification depends on the LCD panel characteristics. Please refer to the manufacturer’s panel specification for details.

Item	Symbol	Min	Max	Unit
Operating Temperature	TOP	0	+50	°C
Operating Humidity	HOP	10	80	%
Storage Temperature	TST	-20	+60	°C
Storage Humidity	HST	10	80	%

1.4 Power Supply Rating

Optional PSU Input Voltage	AC 100 ~ 240VAC,50/60Hz			
Optional PSU Output Voltage	DC 24V/5.0A			
Monitor DC Input Voltage	24VDC			
Power Consumption	TBD			
LED String Lighting Specification (5V Addressable, w/IC type)	Min	Typ.	Max	Unit
Input Voltage	4.75	5.0	5.25	[V]
Input Current		6.72		[A]
Power Consumption		33.6		[W]

- Conditions of Measurement
 - 1) LED pattern: LED Bar full white light, non-scrolling.
 - 2) Current consumption tolerance: + 10%.

2. User control & OSD

2.1 Key control board

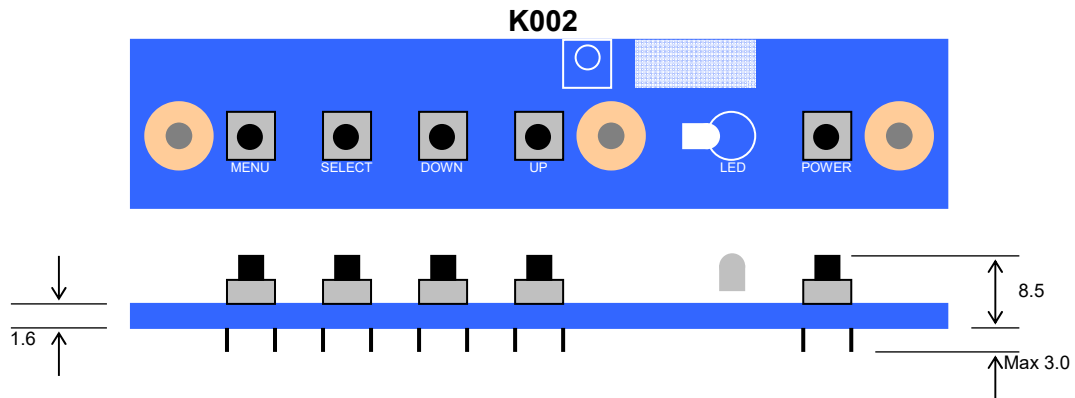

Button	Function	Status	HOT Key
LED	Indicates operation status	Green : Normal State Red : Off Mode Amber : DPMS Mode	
POWER	Power on/off		
MENU	Enable MENU Window Disable MENU Window Exit from Sub function		
SELECT	Select function		No OSD Window, Input Source Change
DOWN	Move to Down or Left		No OSD Window, Auto Color
UP	Move to Up or Right		No OSD Window, Auto Configuration

2.2 OSD Control function

The chosen OSD settings will be stored in memory. The OSD menu can be cleared from the screen by pressing the MENU button otherwise it will be automatically cleared after a few second of non-use.

OSD MAIN MENU

[PICTURE]

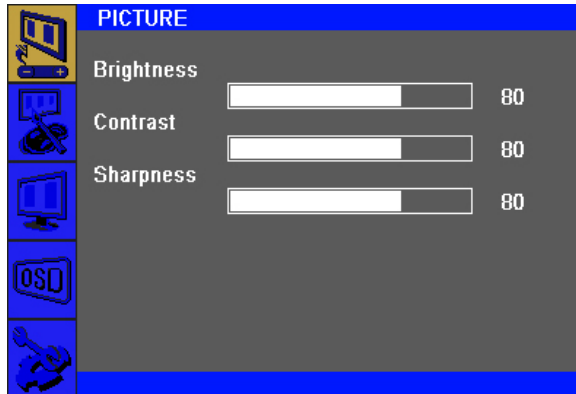

[COLOR]

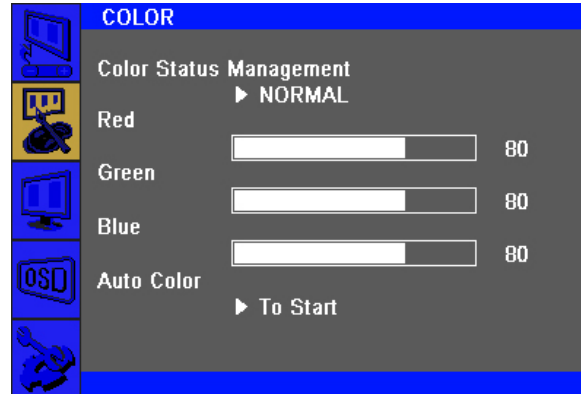

[SCREEN]

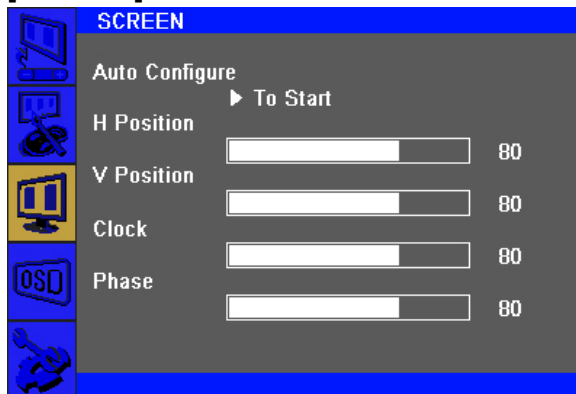

[OSD]

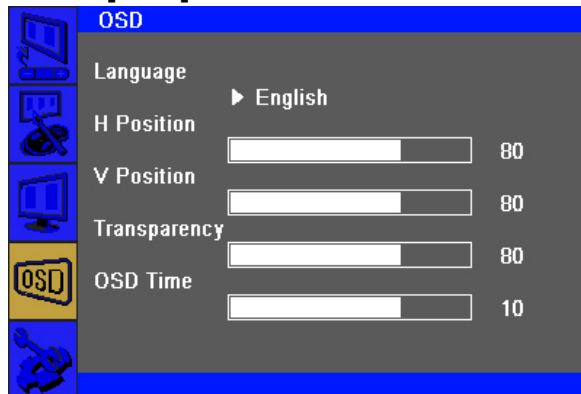

[SETUP]



[Input Source]

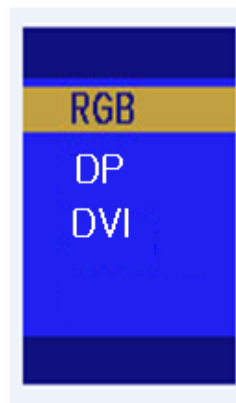

2.3 OSD GUI Control Table

MAIN MENU	SUB MENU	CONTROL	
Picture	Brightness	50(0~100)	
	Contrast	50(0~100)	
	Sharpness	2(0 ~ 4)	
Color	Color Status Management	User(User, Warm, Normal, Cool)	
	Red	50(0~100)	
	Green	50(0~100)	
	Blue	50(0~100)	
	Auto Color	To Start	
Auto Configure	To start		
SCREEN	H Position	50(0~100)	PC ONLY
	V Position	50(0~100)	
	Clock	50(0~100)	
	Phase	30(0~100)	
	WXGA Mode	Off (Off, 1024 x 768, 1280 x 768, 1360 x 768, 1366 x 768)	
	Language	English(English, Deutsh, Francais, Italiano, Espanol, Korean)	
OSD	H Position	50(0~100)	
	V Position	50(0~100)	
	Transparency	33 (0~100)	
	OSD Time	10(3~30)	
	Source	RGB, DVI, DP, AUTO	
SETUP	Factory reset	To Start	
	Aspect	Off(On/Off)	

3. Connector Description

3.1 Summary

Reference	Item	Description	Type	Manufacture
J7	Connector	DP Input Connector	20P DP	-
J1	Connector	VGA Input Connector	15P D-SUB	-
J2	Jack	12V Input DC Power Jack	DC-005	(Optional)
J6	Jack	24V Input DC Power Jack	KPJ-4S-S	
J4	Connector	12VDC/5VDC External Output Conector	SMW200-06	YEONHO
J5,J8	Connector	LCD Backlight Inverter Connector	20010WS-10	YEONHO
J9	Connector	External 12V/24V Power Input	SMW200-04	YEONHO
J10	Connector	Auto-Dimming / RS-232C	SMW200-05	YEONHO
J14,16	Connector	LCD Interface Connector (2Ch LVDS)	YDW200-30	YEONHO
J15	Connector	OSD Board Connector	SMAW200-07	YEONHO
J26	Connector	Speaker Output	SMW200-04	YEONHO
J901	Connector	DVI-D Input(TMDS) Connector	DVI-D24P	-
J904	Connector	VGA / DVI Audio Input Jack	3.5Pai Stereo	

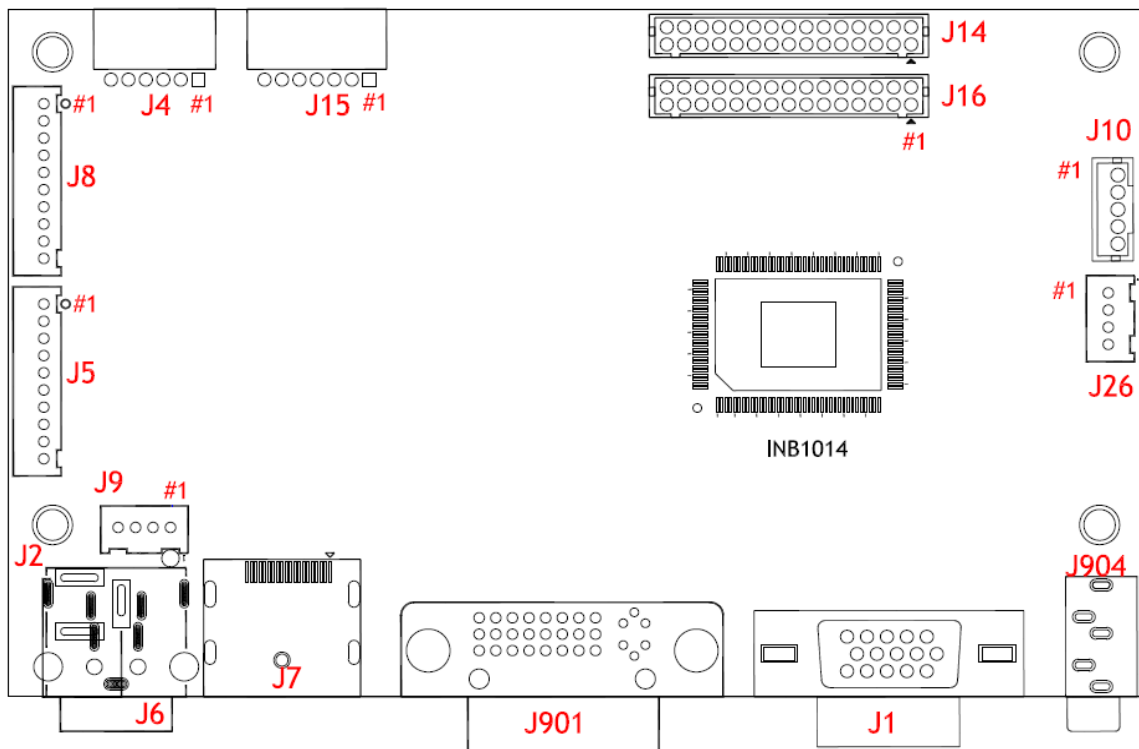

3.2 J7: DP (Display Port) Input

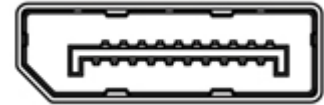

Pin No.	Symbol	Description
1	LANE3-	Component Signal for Main Link 3
3	LANE3+	True Signal for Main Link 3
4	LANE2-	Component Signal for Main Link 2
6	LANE2+	True Signal for Main Link 2
7	LANE1-	Component Signal for Main Link 1
9	LANE1+	True Signal for Main Link 1
10	LANE0-	Component Signal for Main Link 0
12	LANE0+	True Signal for Main Link 0
13	CA DET	NC
14	DP DET+	NC
15	AUX CH+	True Signal for Auxiliary Channel
17	AUX CH-	Component Signal for Auxiliary Channel
18	+5V Power	Identify the presence of a monitor
19	RETURN	NC
20	PWR OUT	NC
16	GND	GROUND

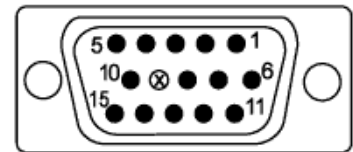

3.3 J1: VGA Input Connector

Pin No.	Symbol	Description
1	Red1	Red analog input
2	Green1	Green analog input
3	Blue1	Blue analog input
4	GND	Ground
5	GND	Ground
6	GND	Ground
7	GND	Ground
8	GND	Ground
9	NC	Not connected
10	GND	Ground
11	GND	Ground

12	DSDA	DDC-SDA
13	HSYNC	Horizontal Sync
14	VSNC	Vertical Sync
15	DSCL	Serial Clock Input

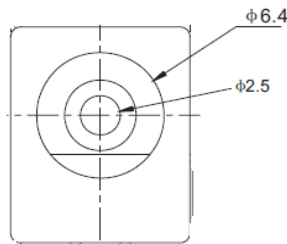

3.4 J2 : 12V Power Input Jack (Optional)

Pin No.	Symbol	Description
-	GND	Ground
+	VCC	12VDC

3.5 J6 : 24V Power Input Jack

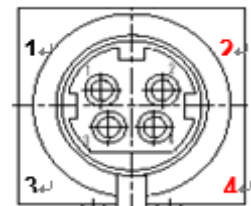

Pin No.	Symbol	Description
1,3	GND	Ground
2,4	VCC	24VDC

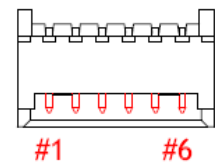

3.6 J4: 12VDC / 5VDC External Output Connector

Pin No.	Symbol	Description
1	12V	12VDC Output
2	12V	12VDC Output
3	5V	5VDC Output
4	5V	5VDC Output

5, 6	GND	Ground
------	-----	--------

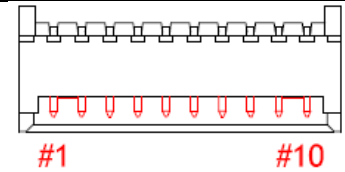

3.7 J5 / J8: LCD Backlight Inverter Connector

Pin No.	Symbol	Description
1	DIM-ADJ	DIM-adjustment analog dimming control signal * make sure inverter specification
2	ON/OFF	Inverter digital ON(3.3V)/OFF(0V) signal
3,4,5,6	GND	Ground
7,8,9,10	VCC	VCC 24V

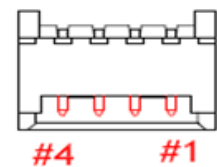

3.8 J9: 12VDC / 24VDC Power Input Connector

Pin No.	Symbol	Description
1	VCC	12VDC / 24VDC
2	VCC	12VDC / 24VDC
3	GND	Ground
4	GND	Ground

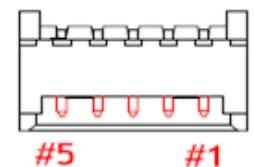

3.9 J10: Auto-Dimming / RS-232C Connector

Pin No.	Symbol	Description
1	VCC	+5V Power For RS-232C
2	RS232	RS232 RX
3	RS232	RS232 TX
4	Auto- Bright	Auto-Dimming
5	GND	Ground



3.10 J14 / J16: LCD Interface Connector (8bit 2Ch LVDS)

Pin No.	Symbol	Description
1	MOD_PWR	Panel Power (12V, 5V or 3.3V)
2	MOD_PWR	Panel Power (12V, 5V or 3.3V)
3	Option	High/Low for LCD Option
4	MOD_PWR	Panel Power (12V, 5V or 3.3V)
5, 6	NC	Not Connection
7	GND	Ground
8	GND	Ground
9	Y3N-EVEN	Negative(-) LVDS differential second 3 data
10	Y3P-EVEN	Positive(+) LVDS differential second 3 data
11	YCN-EVEN	Negative(-) LVDS differential second Clock
12	YCP-EVEN	Positive(+) LVDS differential second Clock
13	Y2N-EVEN	Negative(-) LVDS differential second 2 data
14	Y2P-EVEN	Positive(+) LVDS differential second 2 data
15	Y1N-EVEN	Negative(-) LVDS differential second 1 data
16	Y1P-EVEN	Positive(+) LVDS differential second 1 data
17	Y0N-EVEN	Negative(-) LVDS differential second 0 data
18	Y0P-EVEN	Positive(+) LVDS differential second 0 data
19	GND	Ground
20	GND	Ground
21	Y3N- ODD	Negative(-) LVDS differential first 3 data
22	Y3P-ODD	Positive(+) LVDS differential first 3 data
23	YCN- ODD	Negative(-) LVDS differential first Clock
24	YCP- ODD	Positive(+) LVDS differential first Clock
25	Y2N- ODD	Negative(-) LVDS differential first 2 data
26	Y2P- ODD	Positive(+) LVDS differential first 2 data
27	Y1N- ODD	Negative(-) LVDS differential first 1 data
28	Y1P- ODD	Positive(+) LVDS differential first 1 data
29	Y0N- ODD	Negative(-) LVDS differential first 0 data
30	Y0P- ODD	Positive(+) LVDS differential first 0 data

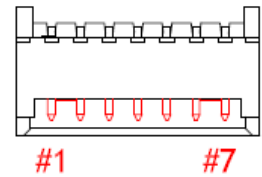

3.11 J15: OSD Board Connector

Pin No.	Symbol	Description
1	VCC	+5V Power for IR sensor
2	IRQ	Infrared rays signal line.
3	LED1	Green LED
4	LED2	Red LED
5	GND	Ground
6	ADC-IN0	Menu, Up
7	ADC-IN1	Power, Down, Up

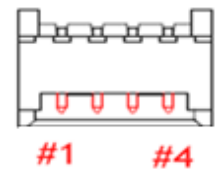
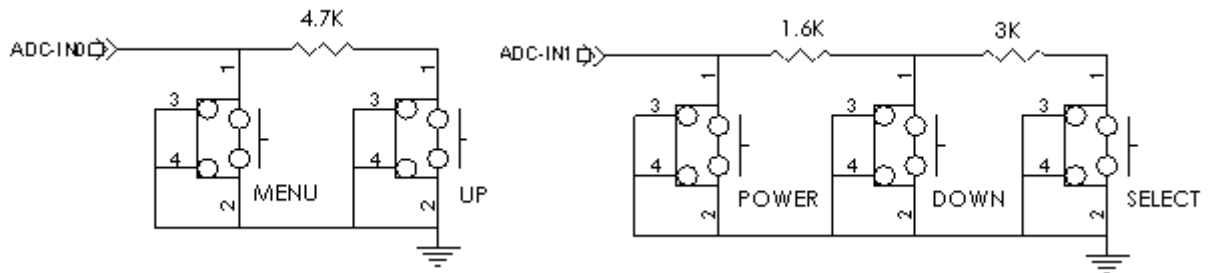

3.12 J26 : Speaker Output Connector

Pin No.	Symbol	Description
1	ROUT+	Speaker Right Output +
2	ROUT-	Speaker Right Output -
3	LOUT+	Speaker Left Output +
4	LOUT-	Speaker Left Output -

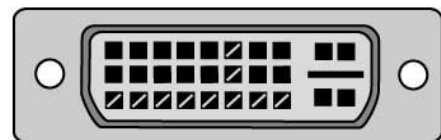

3.13 J901: DVI-D Input (TMDS) Connector

Pin No.	Symbol	Description
1	TMDS DATA2-	TMDS DATA2 Differential Negative Signal
2	TMDS DATA2+	TMDS DATA2 Differential Positive Signal
3	TMDS DATA2 Shield	Shield for TMDS Channel #2
4	NC	No Connection
5	NC	No Connection
6	DDC Clock	The Data Line for the DDC Interface
7	DDC Data	The Clock Line for the DDC Interface
8	NC	No Connection
9	TMDS DATA1-	TMDS DATA1 Differential Negative Signal
10	TMDS DATA1+	TMDS DATA1 Differential Positive Signal
11	TMDS DATA1 Shield	Shield for TMDS Channel #1
12	NC	No Connection
13	NC	No Connection
14	+5V Power	+5 Volt signal for EDID (Un-powered Monitor)
15	GND(for +5V)	Ground for +5 Volt Power pin, Sync return
16	HPD	Identify the Presence of a Monitor
17	TMDS DATA0-	TMDS DATA0 Differential Negative Signal
18	TMDS DATA0+	TMDS DATA0 Differential Positive Signal
19	TMDS DATA0 Shield	Shield for TMDS Channel #0
20	NC	No Connection
21	NC	No Connection
22	TMDS CLOCK Shield	Shield for TMDS Clock Differential Pair
23	TMDS CLOCK+	TMDS DATA0 Differential Positive Signal
24	TMDS CLOCK-	TMDS DATA0 Differential Negative Signal

3.14 J904 : Audio Input (VGA / DVI Input Only) Connector

Pin No.	Symbol	Description
1	GND	GND
2	AR IN-	Sound Right Output
3	AR IN+	Sound Right Ground
4	AL IN-	Sound Left Ground
5	AL IN+	Sound Left Output



4. Standard Display Modes

ITEM	STD	Resolution	Pixel Frequency (MHz)	Vertical Frequency (Hz)	Horizontal Frequency (KHz)	Sync. Polarity (H/V)	Remark
1		640*400	25.175	59.940	31.469		
2		640*480	25.175	59.940	31.469		VGA
3	VESA	640*480	25.200	60.000	31.500		VGA
4	VESA	640*480	31.500	72.809	37.861		VGA
5	VESA	640*480	31.500	75.000	37.500		VGA
6	IBM	720*400	28.322	70.087	31.469		
7	VESA	800*600	36.000	56.250	35.156		SVGA
8	VESA	800*600	40.000	60.317	37.879		SVGA
9	VESA	800*600	50.000	72.188	48.077		SVGA
10	VESA	800*600	49.500	75.000	46.875		SVGA
11	VESA	1024*768	65.000	60.000	48.363		XGA
12	VESA	1024*768	75.000	70.069	56.476		XGA
13	VESA	1024*768	78.750	75.029	60.023		XGA
14		1152*864	94.500	70.012	63.851		
15	VESA	1152*864	108.000	75.000	67.500		
16		1280*720	74.501	59.856	44.772		WXGA
17		1280*768	79.499	59.870	47.776		WXGA
18	VESA	1280*960	108.000	60.000	60.000		WXGA
19		1360*768	72.000	59.960	47.368		WXGA
20	VESA	1280*1024	108.000	60.020	63.981		SXGA
21	VESA	1280*1024	135.000	75.025	79.976		
22		1680*1050	146.250	59.954	65.290		WSXGA+
23		1600* 900	118.998	55.920	60.000		
24		1920*1080	138.500	59.934	66.587		
25		1920*1080	148.500	60.000	67.500		1080P
26		1920*1080	148.352	59.940	67.433		1080P

5. LED Backlight Driver Board Specification

5.1 Electrical Specification

	Item	Symbol	Condition	Min	Typ	Max	Unit	Note	
1	Power Supply Input Voltage	V _{DDB}	-	22.8	24	25.2	V	-	
2	Power Supply Input Current	I _{DDB}	V _{DDB} =24V		2.4	2.74	A	1	
3	Power Consumption	P _{DDB}	V _{DDB} =24V		57.67	65.65	Watt	1	
4	Inrush Current	I _{RUSH}	V _{DDB} =24V			TBD	A	2	
5	Control signal voltage	V _{Signal}	Hi	V _{DDB} =24V	2	-	5.5	V	-
			Low		0	-	0.8		3
6	Control signal current	I _{Signal}	V _{DDB} =24V	-	-	1.5	mA	-	
7	External PWM Duty ratio (input duty ratio)	D_EPWM	V _{DDB} =24V	10	-	100	%	4	
8	External PWM Frequency	F_EPWM	V _{DDB} =24V	120	-	960	Hz	4	
9	DET status signal	DET	Hi	V _{DDB} =24V	Open Collector		V	5	
			Lo		0	-	0.8	V	5
10	Input Impedance	R _{in}	V _{DDB} =24V	300			Kohm	-	
11	LED lifetime	LTLED	-	50,000	-	-	Hr	6	

5.4 Interface

5.4.1 CN1 Connector: 20010WR-14 (YeonHo) or EQ

Pin	Symbol	Remarks
1,2,3,4,5	V _{in}	Input Voltage 24VDC
6,7,8,9,10	GND	GND
11	DET	BLU status detection (Normal : 0 ~ 0.8V)
12	On/Off	Backlight On/Off (5V:On, 0V : Off)
14	PDIM	External PWM
13	NC	No Connection

6. Board Dimensions

6.1 AD Board (INB1014) Dimension (130mm x 80mm x 14.5mm)

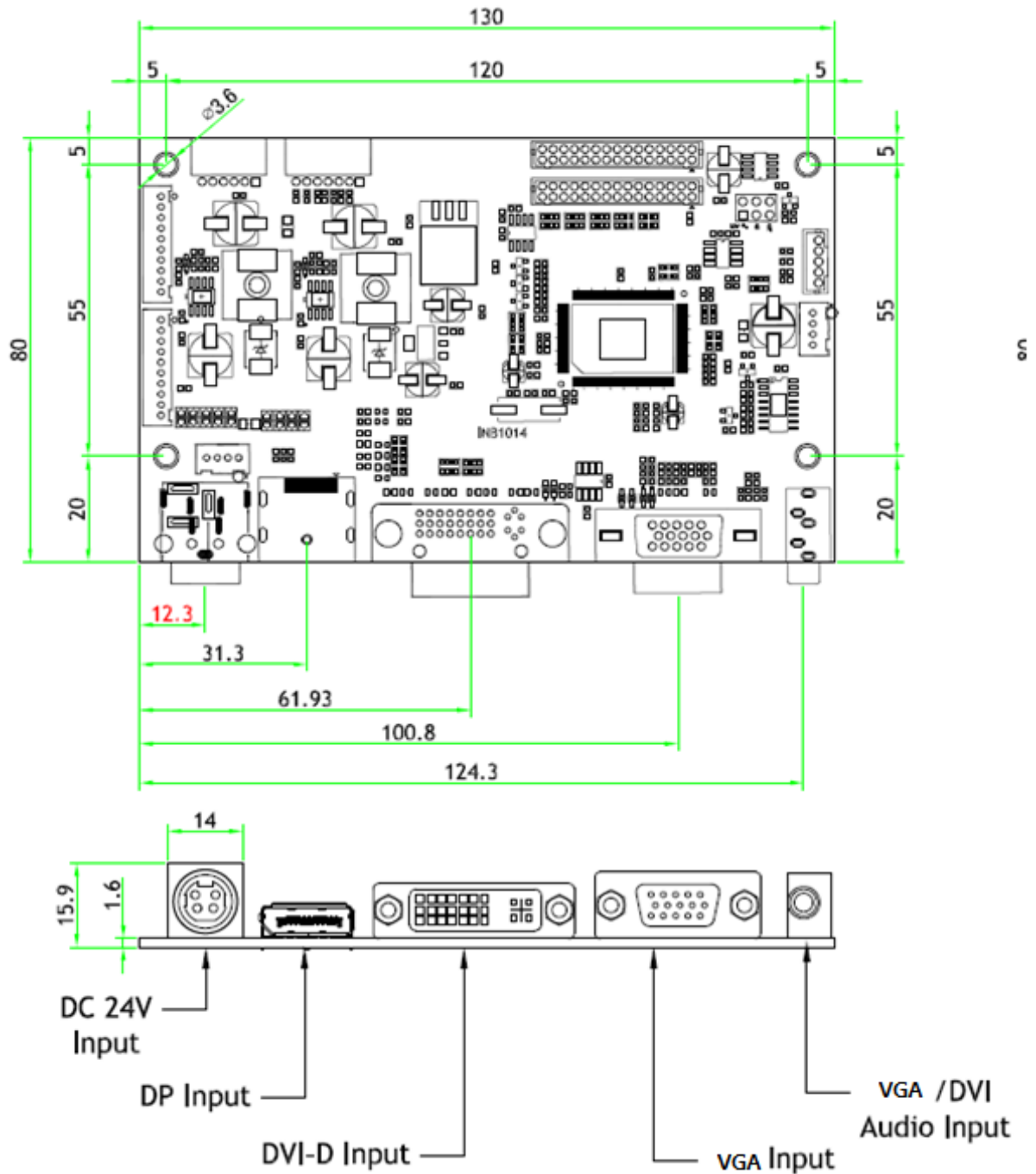

6.2 OSD Board (K002) Dimension (115mm x 20mm x 8.7mm)

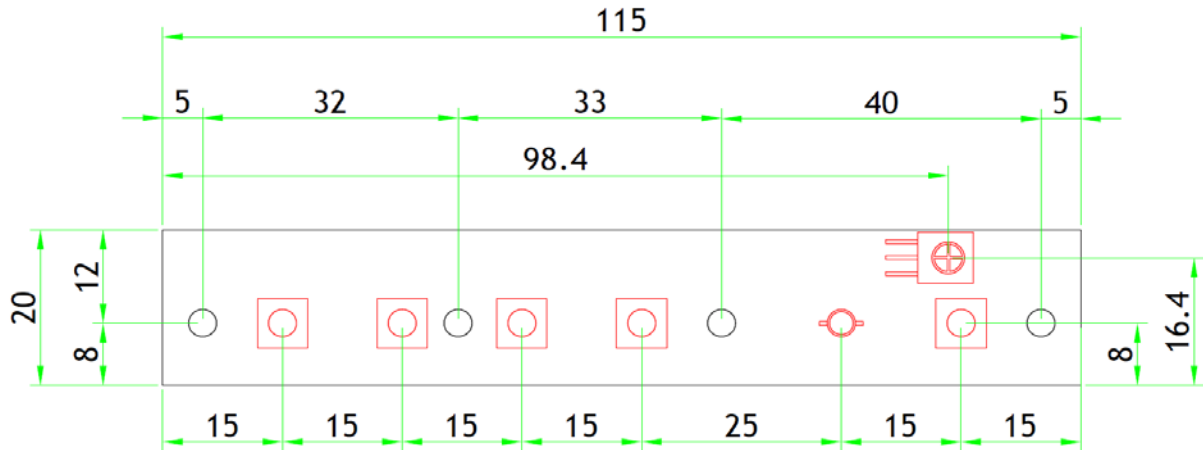

7. LED Lighting Control Interface Specification

7.1 Connector Spec

- Connector: Molex 43020-0600



- Matching Housing: Molex 43025-0600



7.2 External LED Connector Pin Map

7.2.1 With IC (Dual-Line) LED Bar Board

LED Lighting Control Port Pin Map (w/ IC)

#1 : 5V, #2 : CTL, #3 : GND

#4 : 5V, #5 : NC, #6 : GND

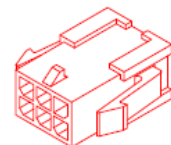
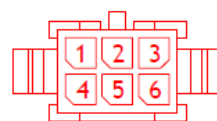

Molex 43020-0600

Pin No	Symbol	Remark
1	5V	DC 5V (Master)
2	CTL	With IC LED Control Line
3	GND	GND
4	5V	DC 5V (Slave)
5	NC	Non Connection
6	GND	GND

7.3 LED (BT5050B) Spec

7.3.1 LED (BT5050B) Pin Configuration

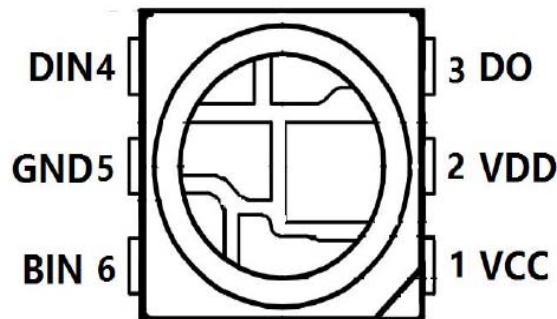

PIN Function

NO.	Symbol	PIN	Function description
1	VCC	VCC	IC POWER SUPPLY
2	VDD	VDD	LED POWER SUPPLY, connect to "+5V"
3	DO	DO	Control data signal output
4	DIN	DIN	Control data signal input
5	GND	GND	Data & Power Grounding
6	BIN	BIN	Backup Control data signal input

7.3., LED (BT5050B) Circuit

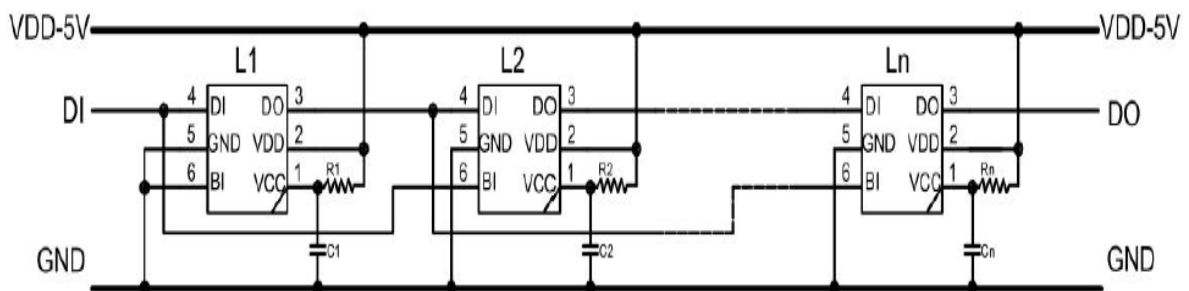

8. Packing Information

Item	Q'ty	Dimension (W x H x D)	Weight(Kg)	Remark
Closed Frame	1Pcs	720.0mm x 720.0mm x 64.0mm	TBD	
Box Packing			TBD	
Pallet Size			TBD	
Pallet Packing			TBD	

9. Mechanical structure

Rev	AMEND	DATE	CHECK	APPR.
P1	Proto	2019.12.24	H.I.Woo	H.Y.Sohn
P2	Changed LCD Panel P600 ----> P236RVN01.0	2021.10.20	H.I.Woo	H.Y.Sohn
P3				

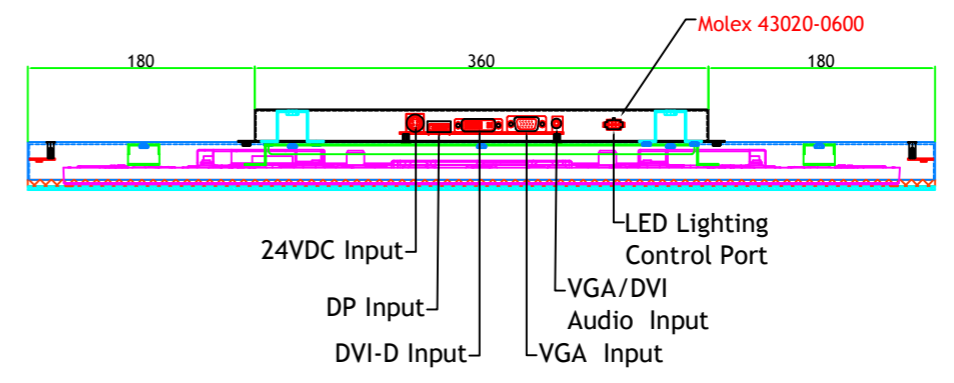
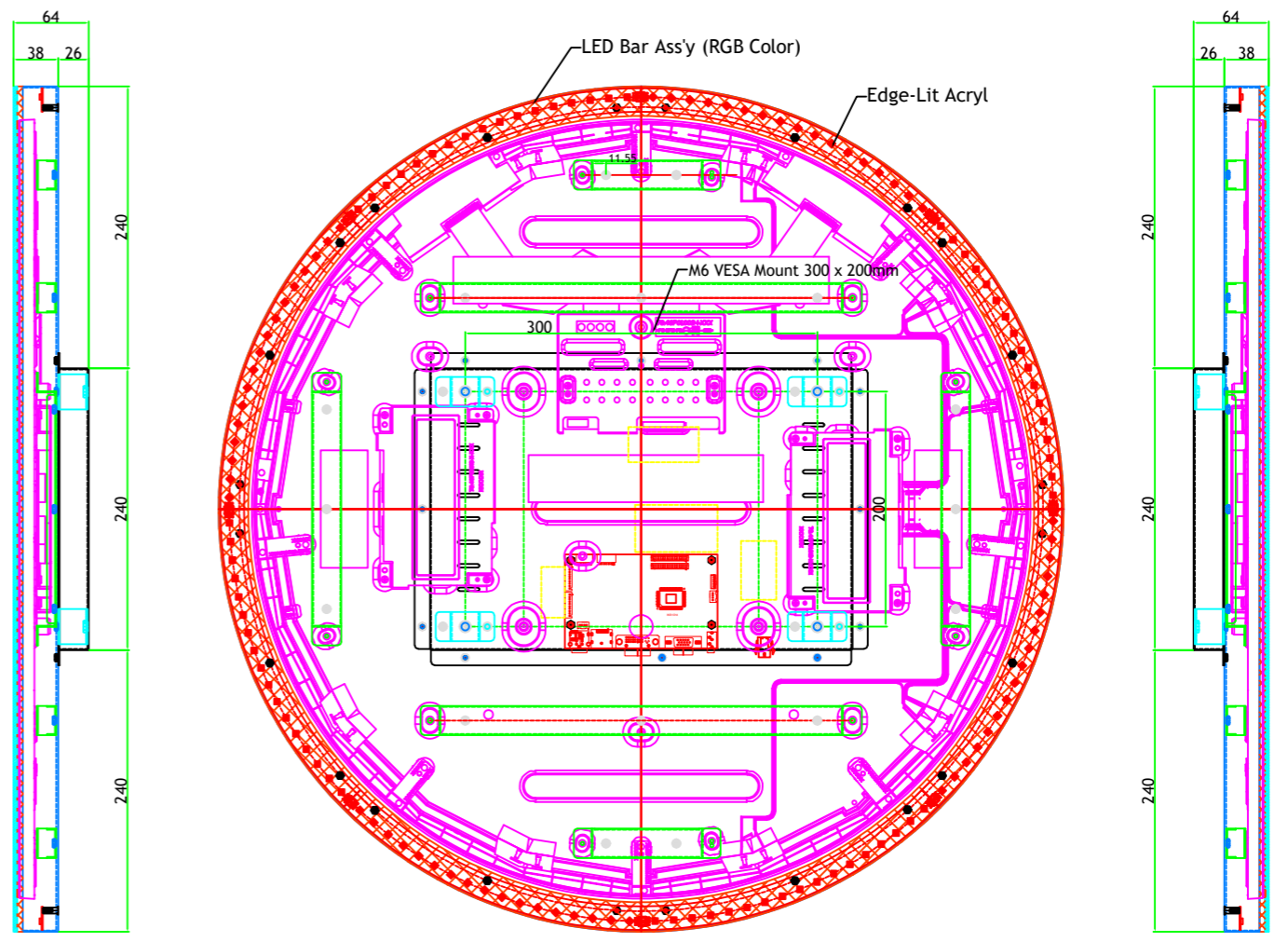
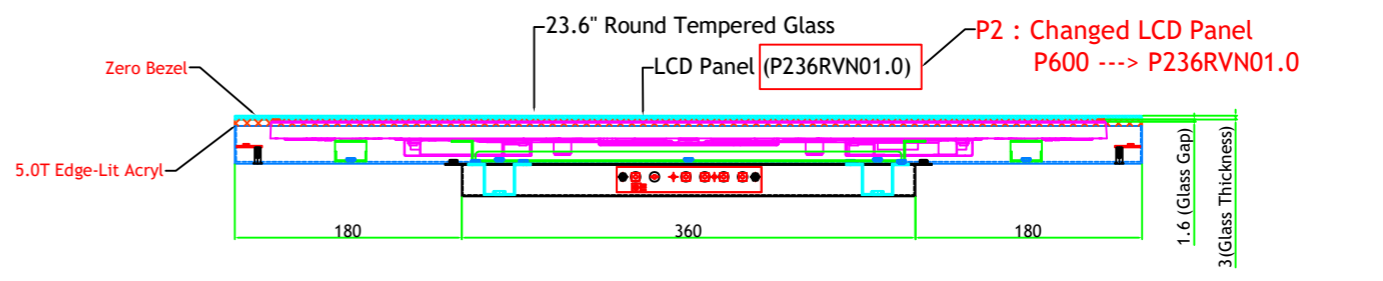
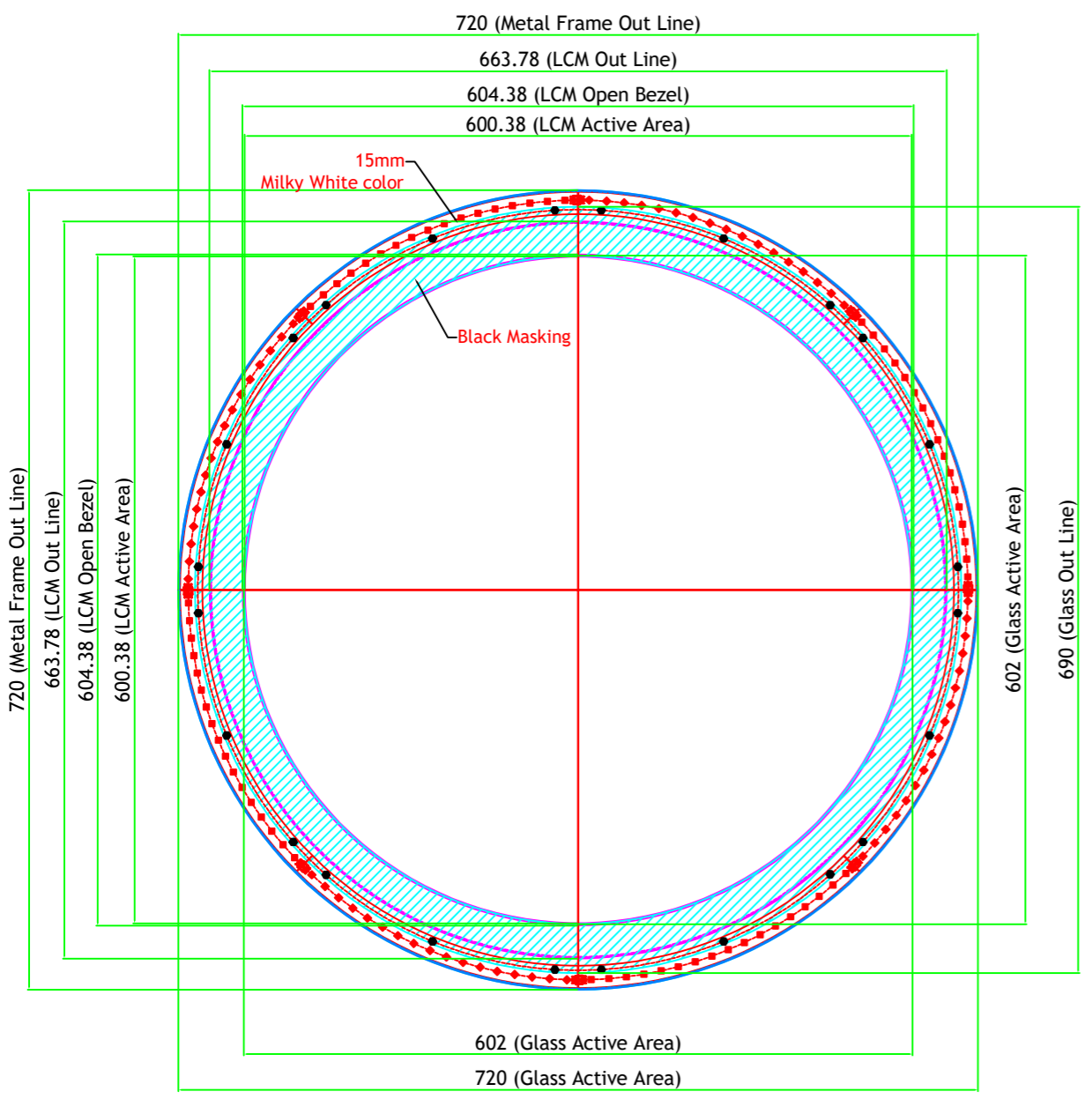

LED Lighting Control Port Pin Map (w/ IC)
 #1 : 5V, #2 : CTL, #3 : GND
 #4 : 5V, #5 : NC, #6 : GND

Molex 43020-0600

		MODEL NO	INC-2363FHAZIG	VIEW :		UNIT :	mm
		NAME	23.6" Closed Frame	Qty	1	REV.	P2
DRAWN	CHECKED	APPROVED	DWG. NO	SCALE	1 / 1		
H.I.Woo		H.Y.Sohn	MATERIAL / FINISH	EGT T=1.0	DATE	2022.07.14	

Rev	AMEND	DATE	CHECK	APPR.
P1	Proto	2019.12.24	H.I.Woo	H.Y.Sohn
P2	Changed LCD Panel P600 ----> P236RVN01.0	2021.10.20	H.I.Woo	H.Y.Sohn

Front View

Rear View

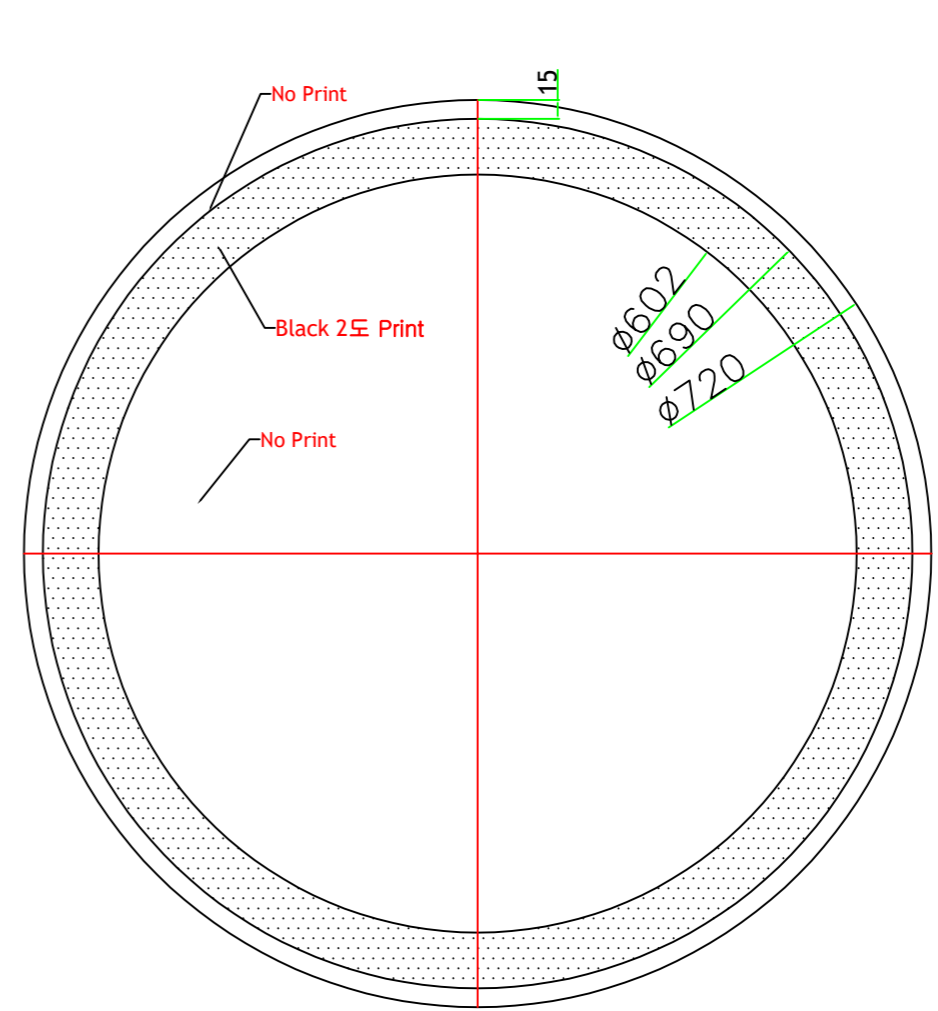
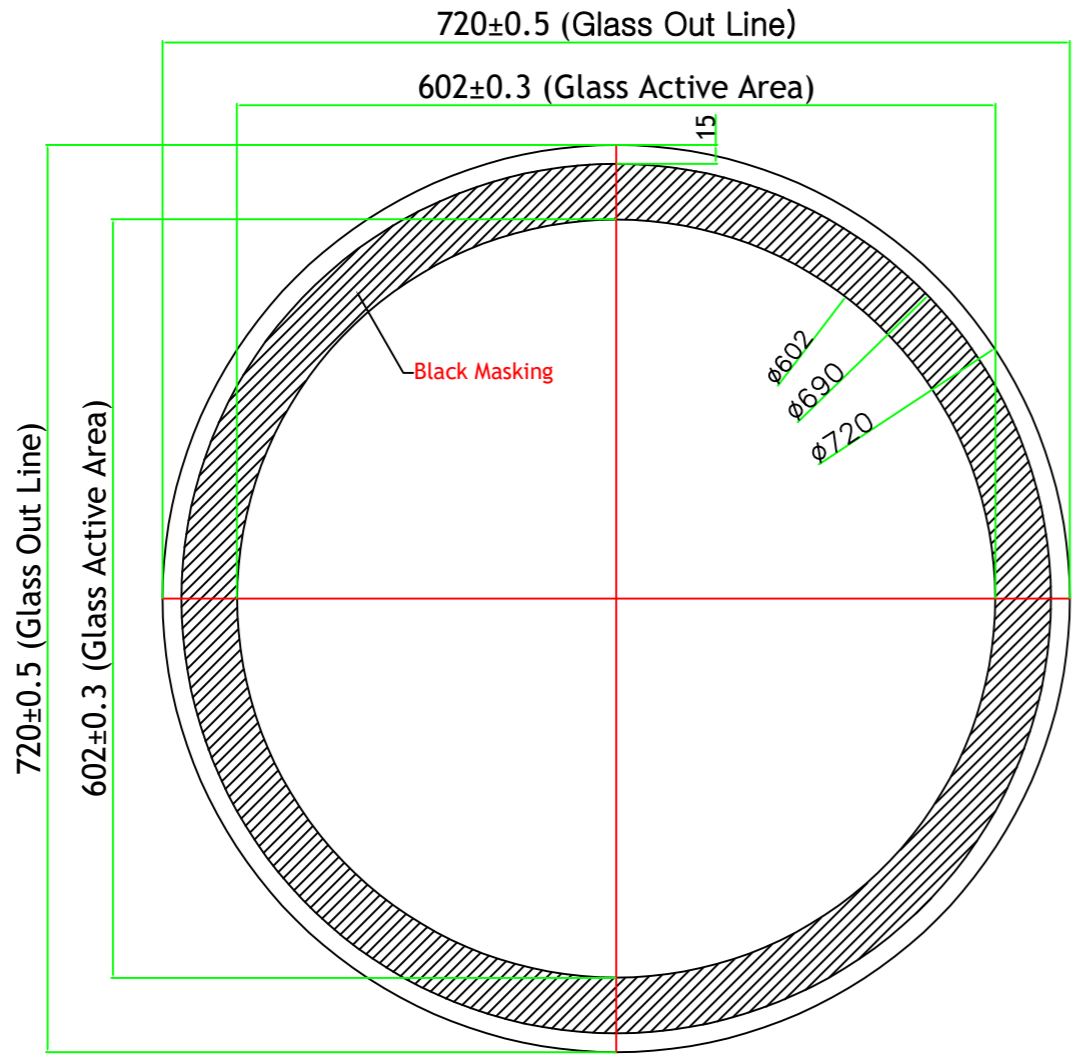

- Black Masking : 2 time

PGLSHT2363001 23.6" Edge-LED Tempered Glass Drawing
V1.0 2019.12.18

		MODEL NO	INC-2363FHAZIG	VIEW :		UNIT : mm
		NAME	23.6" Closed Frame	Qty	1	REV.
DRAWN	CHECKED	APPROVED	DWG. NO	4M2363001-02	SCALE	1 / 1
H.I.Woo		H.Y.Sohn	MATERIAL / FINISH	EGI T=1.0	DATE	2022.07.14

ASSEMBLY ITEM NUMBER	PART CHARACTERISTICS		MATERIAL
	NUMBER OF POSITION	PANEL MOUNT OPTION	
	43020-0200	02	
43020-0201	02	NO	
43020-0400	04	YES	
43020-0401	04	NO	
43020-0600	06	YES	
43020-0601	06	NO	
43020-0800	08	YES	
43020-0801	08	NO	
43020-1000	10	YES	
43020-1001	10	NO	
43020-1200	12	YES	
43020-1201	12	NO	
43020-1400	14	YES	
43020-1401	14	NO	
43020-1600	16	YES	
43020-1601	16	NO	
43020-1800	18	YES	
43020-1801	18	NO	
43020-2000	20	YES	
43020-2001	20	NO	
43020-2200	22	YES	
43020-2201	22	NO	
43020-2400	24	YES	
43020-2401	24	NO	

CKT. NO.	DIM. 'A'	DIM. 'B'	DIM. 'C'	DIM. 'D'
2	.152/(3.86)	N/A	.166/(4.21)	.311/(7.90)
4	.270/(6.85)	.118/(3.00)	.284/(7.21)	.429/(10.90)
6	.388/(9.85)	.236/(6.00)	.402/(10.21)	.547/(13.89)
8	.506/(12.85)	.354/(9.00)	.520/(13.21)	.665/(16.89)
10	.624/(15.85)	.472/(12.00)	.638/(16.21)	.783/(19.89)
12	.742/(18.85)	.591/(15.00)	.756/(19.21)	.901/(22.89)
14	.860/(21.85)	.709/(18.00)	.874/(22.20)	1.019/(25.88)
16	.978/(24.85)	.827/(21.00)	.992/(25.20)	1.137/(28.88)
18	1.096/(27.85)	.945/(24.00)	1.110/(28.20)	1.255/(31.88)
20	1.215/(30.85)	1.063/(27.00)	1.229/(31.22)	1.373/(34.87)
22	1.333/(33.85)	1.181/(30.00)	1.347/(34.22)	1.491/(37.87)
24	1.451/(36.85)	1.299/(33.00)	1.465/(37.22)	1.609/(40.87)

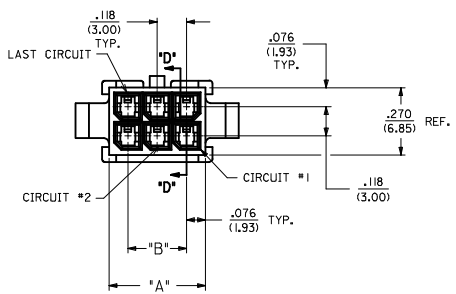

- NOTES:
- HOUSING MATERIAL:
 - 'A' - UNFILLED POLYESTER, RATED UL, 94V-0, COLOR IS BLACK.
 - 'B' - UNFILLED NYLON, RATED UL, 94V-0, HALOGEN-FREE, COLOR IS BLACK.
 - FINISH: N/A
 - PRODUCT SPECIFICATION: PS-43045
 - PACKAGING SPECIFICATION: PK-43020-001
 - THIS HOUSING MATES WITH MICRO-FIT RECEPTACLE #43025-****
 - THIS HOUSING TO BE USED WITH MOLEX MALE TERMINAL #43031-****
 - DESIGNED FOR .055(1.4) MINIMUM TO A .100(2.54) MAXIMUM THICK PANEL OR PRINTED CIRCUIT BOARD.
 - SEE SECTION 'D'-'D' FOR TERMINAL ORIENTATION IN HOUSING.
 - PANEL MOUNT FEATURES MUST LOCK ON SIDE OPPOSITE PUNCH SIDE FOR OPTIMUM RETENTION.
 - PART CONFORMS TO CLASS 'B' REQUIREMENTS OF COSMETIC SPECIFICATION PS-45499-002. SOME HOUSINGS MAY HAVE A SMALL GATE BLEMISH NEAR THE GATE LOCATION THAT DOES NOT AFFECT FUNCTIONALITY.

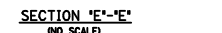
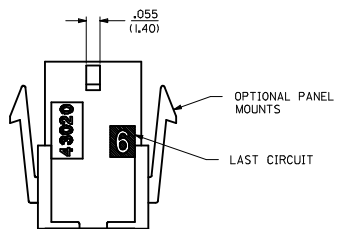
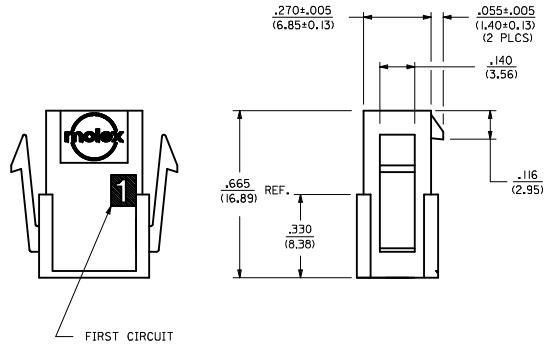
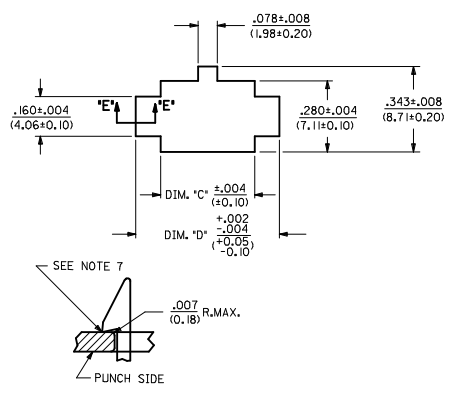

SECTION 'E'-'E'
NO SCALE

RECOMMENDED PANEL CUT-OUT
(SEE NOTES 7 & 9)

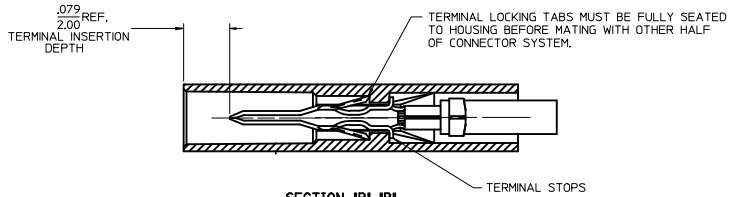

SECTION 'B'-'B''

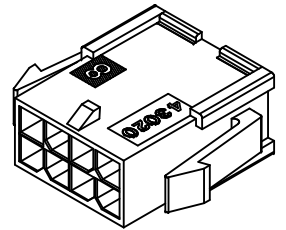

PLUG WITH OPTIONAL
PANEL MOUNTS
ISO VIEW
(8 CIRCUIT SHOWN)

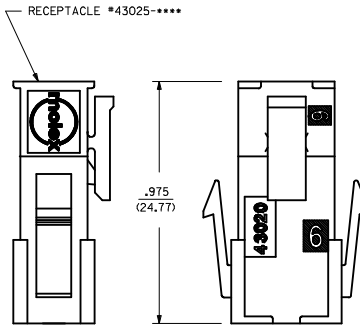

MATED MICRO-FIT CONNECTOR

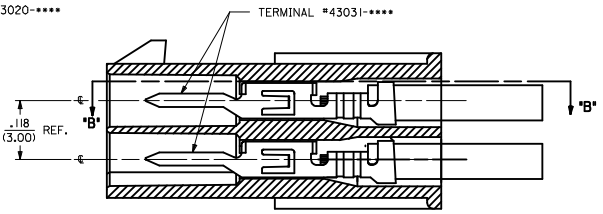

SECTION 'D'-'D'
WITH TERMINAL
SCALE 8X

UPDATE PUNCHED HOLE EC NO. UCP2017-0525 DRAWN/OUTLES 2016/09/13 CHKD/SSOUSEK 2016/09/13 APPR/FSM TH 2016/10/07	QUALITY SYMBOLS ▽=0 ▽=0 ▽=0	GENERAL TOLERANCES (UNLESS SPECIFIED)		DIMENSION STYLE		SCALE	DESIGN UNITS	THIRD ANGLE PROJECTION
		mm	INCH	IN/MM		METRIC		
		4 PLACES ±.010	±.010	DRAWN BY	DATE			
		3 PLACES ±.014	±.014	AFG	1993/01/07			
		2 PLACES ±0.25	±.014	CHECKED BY	DATE			
		1 PLACE ±0.35	±.014	BAP	1993/01/07			
		0 PLACE ±---	±---	APPROVED BY	DATE			
				FSMITH	2016/10/07			
				ANGULAR ±1/2°		MATERIAL NO.		
				DRAFT WHERE APPLICABLE MUST REMAIN WITHIN DIMENSIONS		SEE CHART	DOCUMENT NO.	
				SIZE D		SDA-43020-****		SHEET NO.
				THIS DRAWING CONTAINS INFORMATION THAT IS PROPRIETARY TO MOLEX INCORPORATED AND SHOULD NOT BE USED WITHOUT WRITTEN PERMISSION				1 OF 1

PART CHARACTERISTICS		
NUMBER OF POSITION	ASSEMBLY ITEM NUMBER	MATERIAL
02	43025-0200	'B'
04	43025-0400	
06	43025-0600	
08	43025-0800	
10	43025-1000	'A'
12	43025-1200	
14	43025-1400	'B'
16	43025-1600	'A'
18	43025-1800	'B'
20	43025-2000	
22	43025-2200	'A'
24	43025-2400	

CKT. NO.	DIM. "A" +0.14 -0.10 +0.35 -0.25	DIM. "B"
2	.152/(3.86)	N/A
4	.270/(6.85)	.118/(3.00)
6	.388/(9.85)	.236/(6.00)
8	.506/(12.85)	.354/(9.00)
10	.624/(15.85)	.472/(12.00)
12	.742/(18.85)	.591/(15.00)
14	.860/(21.85)	.709/(18.00)
16	.978/(24.85)	.827/(21.00)
18	1.096/(27.85)	.945/(24.00)
20	1.215/(30.85)	1.063/(27.00)
22	1.333/(33.85)	1.181/(30.00)
24	1.451/(36.85)	1.299/(33.00)

- NOTES:**
- HOUSING MATERIAL:
'A' - UNFILLED POLYESTER, RATED UL, 94V-0, COLOR IS BLACK.
'B' - UNFILLED NYLON, RATED UL, 94V-0, HALOGEN-FREE, COLOR IS BLACK.
 - FINISH: N/A
 - PRODUCT SPECIFICATION: PS-43045
 - PACKAGING SPECIFICATION: PK-43025-001
 - THIS RECEPTACLE MATES WITH 43020, 43045.
 - THIS RECEPTACLE TO BE USED WITH MOLEX FEMALE TERMINAL SERIES 43030 OR 46235. SEE SECTION 'A'-A' FOR TERMINAL ORIENTATION IN HOUSING.
 - FOR OVERMOLDING PARAMETERS SEE ENGINEERING SPECIFICATION #SDS-43025-1000.
 - TOP PULL TABS ARE NOT AVAILABLE ON 2 AND 4 CIRCUIT PARTS.
 - MOLEX RECOMMENDS THE USE OF MICRO-FIT TEST PLUG, SERIES NO. 44242-***** WHENEVER TESTING IS PERFORMED. TEST PLUGS MUST NOT BE USED FOR MAKE OR BREAK UNDER LOAD. MOLEX DOES NOT RECOMMEND USING STANDARD MATING COMPONENTS FOR HARNESS TESTING PURPOSES.
 - SOME HOUSINGS MAY HAVE A SMALL GATE BLEMISH NEAR THE GATE THAT DOES NOT AFFECT FUNCTIONALITY.
 - HOUSINGS HAVE EITHER AN IDENTIFIER RIB OR ENGRAVED '1' SYMBOL TO INDICATE CIRCUIT #1. IDENTIFIER TYPE IS TOOL DEPENDENT AND NOT SELECTABLE.
 - DIMENSION 'A' MEASURED AT DATUM \square -A-
 - THIS PART CONFORMS TO CLASS 'B' REQUIREMENTS OF COSMETIC SPECIFICATION PS-45499-002.

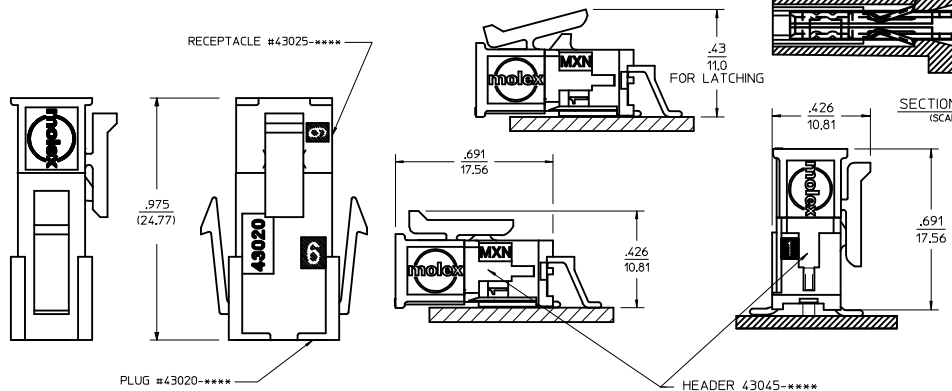
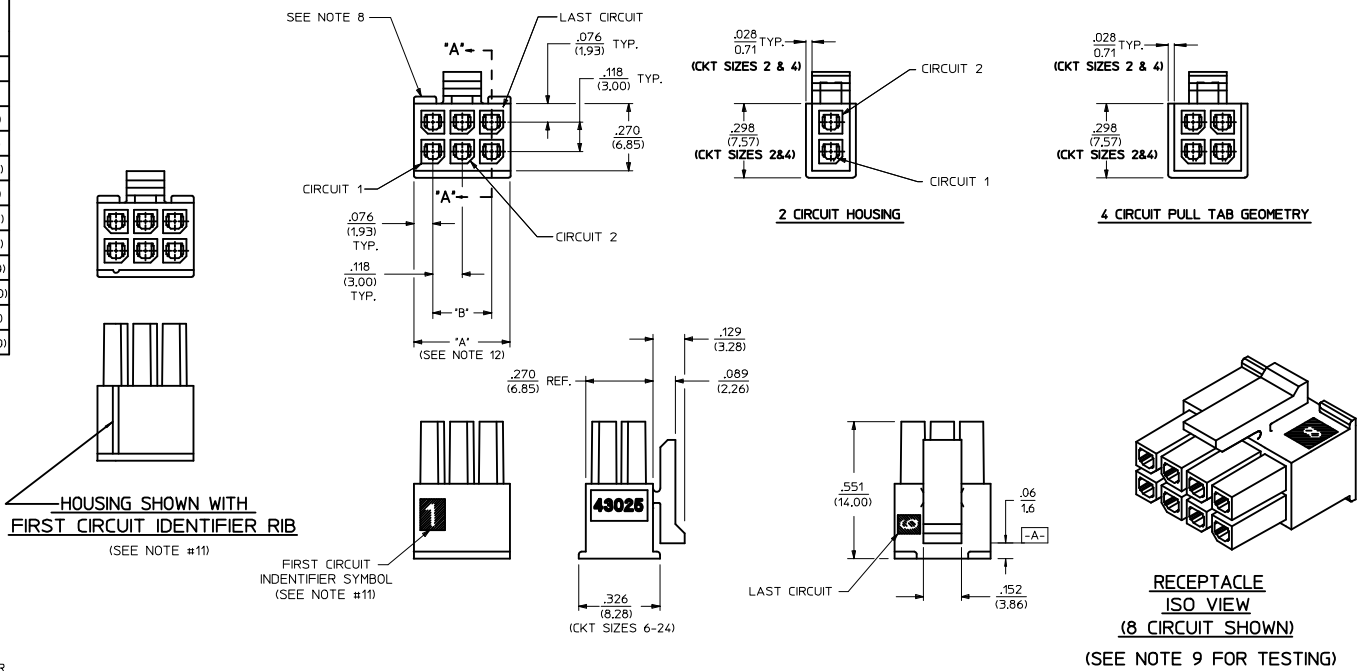

MATED MICRO-FIT CONNECTOR

ADD MATED VIEW IEC NO: UCP2016-4677 DRAWN BY: DRYNWAPELDOORN CHECKED BY: CHYKJDOFX APPROVED BY: APPREHSMITH DATE: 2016/06/03 DATE: 2016/06/03 DATE: 2016/06/09	QUALITY SYMBOLS ∇=0 ∇=0 ∇=0	GENERAL TOLERANCES (UNLESS SPECIFIED): <table border="1"> <tr> <th></th> <th>mm</th> <th>INCH</th> </tr> <tr> <td>4 PLACES</td> <td>±.010</td> <td>±.010</td> </tr> <tr> <td>3 PLACES</td> <td>±.014</td> <td>±.014</td> </tr> <tr> <td>2 PLACES</td> <td>±.025</td> <td>±.010</td> </tr> <tr> <td>1 PLACE</td> <td>±.035</td> <td>±.014</td> </tr> <tr> <td>0 PLACE</td> <td>±.050</td> <td>±.020</td> </tr> </table>		mm	INCH	4 PLACES	±.010	±.010	3 PLACES	±.014	±.014	2 PLACES	±.025	±.010	1 PLACE	±.035	±.014	0 PLACE	±.050	±.020	DIMENSION STYLE IN/MM DRAWN BY: DATE A. F. G. 1993/01/14 CHECKED BY: DATE B. A. P. 1993/01/14 APPROVED BY: DATE FSMITH 2016/05/02	SCALE METRIC DESIGN UNITS METRIC THIRD ANGLE PROJECTION	MATERIAL NO. SEE CHART DOCUMENT NO. SDA-43025-*****	SHEET NO. 1 OF 1
		mm	INCH																					
	4 PLACES	±.010	±.010																					
	3 PLACES	±.014	±.014																					
2 PLACES	±.025	±.010																						
1 PLACE	±.035	±.014																						
0 PLACE	±.050	±.020																						
ANGULAR ±1/2° DRAFT WHERE APPLICABLE MUST REMAIN WITHIN DIMENSIONS			micro-fit (3.0) 2 THRU 24 CIRCUIT RECEPTACLE molex																					
SIZE D			THIS DRAWING CONTAINS INFORMATION THAT IS PROPRIETARY TO MOLEX INCORPORATED AND SHOULD NOT BE USED WITHOUT WRITTEN PERMISSION																					
REV 04																								